



>100.000 h
@ tc=85 °C



CRI

>80
>90 available online

Available (CCT) colour temperature

3000 K
4000 K
5000 K

2700 K on request - su richiesta
3500 K on request - su richiesta
5700 K on request - su richiesta
6500 K on request - su richiesta

Beam angle

120 °

Ambient temperature

ta: -40...+55 °C
(Only for tc ≤ 85 °C)

Module temperature

tc: 85 °C

Absolute maximum operating current:

380 mA

Standards compliance

CSA-C22.2 no.250
EN 55015
EN 62031
EN 62471
IEC TR 62778
UL 8750

LM70/24Y4



LM280/24Y12



LM560/24Y24



Article Articolò	Code Codice	CCT K	Current mA	Flux tc 25°C lm	Flux tc 65°C lm	Power tc 65°C W	Efficacy tc 25°C lm/W	Efficacy tc 65°C lm/W	Vmin. tc 25°C @Imin	Vmax. tc 25°C @Imax
LM70/24Y4	128163/830V	3000	250	275	264	1,4	194	191	5,7	5,9
			300	326	313	1,7	190	187		
			350	376	361	2	186	183		
	128163/840V	4000	250	290	278	1,4	205	201		
			300	344	330	1,7	201	197		
			350	396	380	2	196	192		
	128163/850V	5000	250	290	278	1,4	205	201		
			300	344	330	1,7	201	197		
			350	396	380	2	196	192		
LM280/24Y12	128165/830V	3000	250	825	792	4,2	194	191	17	17,4
			300	978	938	5	190	187		
			350	1127	1082	5,9	186	183		
	128165/840V	4000	250	870	835	4,2	205	201		
			300	1031	989	5	201	197		
			350	1188	1140	5,9	196	192		
	128165/850V	5000	250	870	835	4,2	205	201		
			300	1031	989	5	201	197		
			350	1188	1140	5,9	196	192		
LM560/24Y24	128167/830V	3000	250	1650	1584	8,4	194	191	34	34,8
			300	1956	1876	10	190	187		
			350	2254	2164	11,8	186	183		
	128167/840V	4000	250	1740	1670	8,4	205	201		
			300	2062	1978	10	201	197		
			350	2376	2280	11,8	196	192		
	128167/850V	5000	250	1740	1670	8,4	205	201		
			300	2062	1978	10	201	197		
			350	2376	2280	11,8	196	192		

The mentioned data can have a 10% tolerance - Il dato indicato può avere una tolleranza del 10%.

Main features

- Combinable modules for an optimal, extensive design. Perfect light uniformity.
- Ideal for **residential, office, retail and industrial lighting**.
- SELV modules (V < 60 V). Suitable for NON-SELV applications: distance between the voltage area and the board edge ≥ 2,7 mm.
- Extended lifetime > **100.000 h**.
- High efficiency: **up to 205 lm/W**.
- Minimum colour tolerance: 3MacAdam (3SDCM).
- Push-in terminal blocks. Easy module fixing with screws.
- Suitable for emergency applications with TCI inverters.
- Only for professional use, not for final end user.

Caratteristiche principali

- Moduli combinabili per un design lineare ottimale, anche estensivo. Luce perfettamente uniforme.
- Moduli ideali per **illuminazione residenziale, uffici, spazi commerciali e industriali**.
- Moduli SELV (V < 60 V). Idonei per applicazioni NON SELV: distanza tra parte in tensione e bordo scheda ≥ 2,7 mm.
- Lifetime esteso > **100.000 h**.
- Elevata efficienza: **fino a 205 lm/W**.
- Minima tolleranza di colore: 3MacAdam (3SDCM).
- Morsetti a innesto rapido. Fissaggio del modulo semplice mediante viti.
- Moduli alimentabili in emergenza con inverter TCI.
- Prodotto ad uso unicamente professionale. Non per impiego da parte dell'utente finale.



Technical features - Caratteristiche tecniche

LM70/24Y4 (Weight/Peso 0,21 oz. / gr. 6 - Pcs/Pezzi 216)

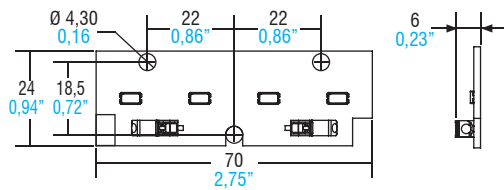

LM280/24Y12 (Weight/Peso 0,74 oz. / gr. 21 - Pcs/Pezzi 48)

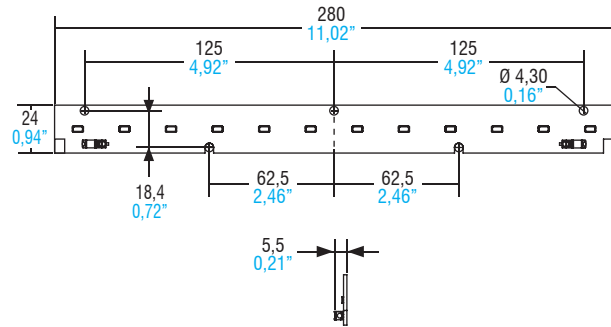

LM560/24Y24 (Weight/Peso 1,66 oz. / gr. 47 - Pcs/Pezzi 48)

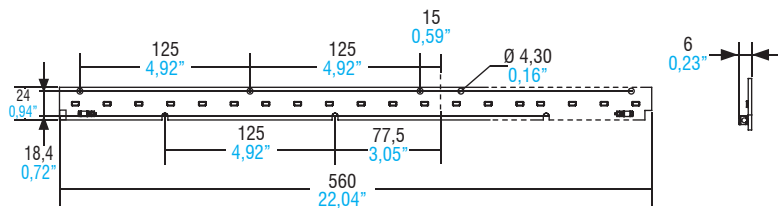

Zhaga compatible holes

Wiring - Cablaggio

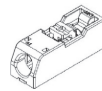

Insert/remove wires by slightly pressing on push-button.
Inserire/rimuovere i cavi premendo leggermente sul pulsante.

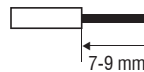

Solid conductor - Conduttore rigido 0,2...0,75 mm² / 24...18 AWG
 Fine-stranded conductor - Conduttore flessibile 0,2...0,75 mm² / 24...18 AWG
 Fine-stranded conductor with ferrule with plastic collar -
 Conduttore flessibile con boccola con isolamento in plastica 0,25...0,34 mm²

Accessories - Accessori

LINEA BOXED
280 mm / 1 ft

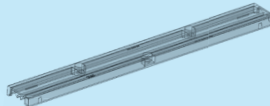

LINEA CLIP
280 mm / 1 ft

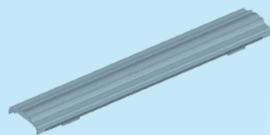

Beam Angle Angolo di orientamento	30°	60°	90°	Double asymmetric
Code - Codice	468780147	468780148	468780149	468780151

CAPS FOR PMMA BOXED LENSES Code 488787434

Beam Angle Angolo di orientamento	30°	60°	90°	20° ASYM	±20° Double asymmetric
Code - Codice	468780231	468780232	468780233	468780234	468780235

CAPS FOR PMMA CLIP LENSES Grey 468780236 Transparent 468780236T

For technical details SEE SECTION 4. Per dettagli tecnici VEDI SEZIONE 4.

Dissipation, assembly

A dissipation of the LED module might be required to guarantee the stated datas of brightness and lifetime. Please verify that the modules Tc does not exceed the maximum values as indicated in the table. It is recommended the use of all the holes for the fixing of the LED module or the use of thermoconductive pastes or adhesives. To avoid any damages to the LED module please use only rounded head screws and an additional plastic flat washer. If the LED modules are wired in parallel and a module fails, all the current flowing through the other LED module increases. This may reduce the lifetime of the LED module.

Handling and Cleaning

Don't give any shock to the LED modules nor store them in a dusty place. Avoid any contacts with any kind of fluid such as oil or organic solvents. It is recommended the use of IPA (isopropyl alcohol) as solvent to clean the LED modules. Before cleaning, a pre-test should be done to verify any possible damages to the LED module.

Static Electricity

Static electricity or surge voltage can damage the LED modules. Always wear anti ESD wrist band or anti ESD gloves when handling the LED modules.

Lifetime

The brightness value of a LED module according to 60.000/80.000 working hours is indicated by letter L. Letter B indicates the number of LEDs that keep the L value also after 60.000/80.000 working hours. TCI LED modules are guaranteed L80B20. In other words the 80% of the LEDs will have 80% or higher rendering after 60.000/80.000 working hours.

Dissipazione e assemblaggio

Per garantire i dati di luminosità e durata indicati può essere necessaria una dissipazione del modulo LED. Verificare che la Tc del modulo non superi i valori massimi indicati nella tabella. Si consiglia l'utilizzo di tutti i fori previsti per il fissaggio del modulo LED o l'utilizzo di pasta o adesivi termoconduttivi. Per non danneggiare i moduli LED utilizzare soltanto viti a testa arrotondata e rondelle plastiche piatte. Se i moduli LED sono collegati in parallelo e un modulo si danneggia, tutta la corrente che passa nell'altro modulo LED aumenta. Questo potrebbe ridurre il lifetime del modulo LED.

Uso e pulizia

Non procurare shock ai moduli LED e conservarli in luogo non polveroso. Evitare il contatto con qualsiasi tipo di fluido, come olio o solventi organici. Si raccomanda l'uso di IPA (alcol isopropilico) quale solvente per la pulizia dei moduli LED. Prima di procedere con la pulizia, dovrebbe essere effettuato un pre-test per accertare potenziali danni al modulo LED.

Elettricità statica

L'elettricità statica o le tensioni di rete possono danneggiare i moduli LED. Indossare un braccialetto ESD o guanti ESD durante l'uso dei moduli LED.

Lifetime

Il valore di luminosità di un modulo LED in base a 60.000/80.000 ore di funzionamento è indicato dalla lettera L. La lettera B indica invece il numero dei LED che rispetteranno il valore L dopo 60.000/80.000 ore di funzionamento. I moduli LED TCI sono garantiti L80B20, che significa che l'80% dei LED avrà una resa pari o superiore all'80% dopo 60.000/80.000 ore di utilizzo.

TCI LED modules are not equipped against mains spikes, overloads and short circuits. The use is guaranteed in combination with TCI drivers.
 I moduli LED TCI non sono protetti contro extra tensioni, sovraccarichi e cortocircuiti. L'utilizzo è garantito in combinazione con driver TCI.

For additional technical informations please visit our website: www.tci.it