

SM250/250E66 - SM270/270E66

TCI[®] LED

SMART series - Square modules

Made in Italy 

CE US  15

2.2

SPACE LIGHTING



> 80.000 h
@ tc=85 °C

SM250/250E66

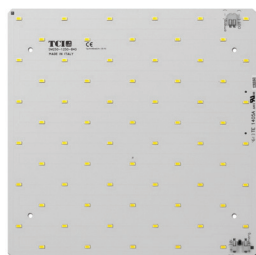

SM270/270E66



CRI

>80
>90 on request - su richiesta

Available (CCT) colour temperature

3000 K
4000 K
5000 K

2700 K on request - su richiesta
3500 K on request - su richiesta
5700 K on request - su richiesta
6500 K on request - su richiesta

Beam angle

120 °

Ambient temperature

ta: -40...+55 °C
(Only for tc ≤ 85 °C)

Module temperature

Tc: 85 °C

Absolute maximum operating current:

900 mA

Standards compliance

CSA-C22.2 no.250
EN 55015
EN 62031
EN 62471
IEC TR 62778
UL 8750

Article Articolò	Code Codice	CCT K	Current mA	Flux tc 25°C lm	Flux tc 65°C lm	Power tc 65°C W	Efficacy tc 25°C lm/W	Efficacy tc 65°C lm/W	Vmin. tc 25°C @Imin	Vmax. tc 25°C @Imax
SM250/250E66	122930/830H	3000	350	1812	1691	10,5	170	161	30,6	32,4
			500	2532	2362	15,3	163	155		
			700	3397	3168	21,7	154	146		
	122930/840H	4000	350	1910	1782	10,5	179	170		
			500	2670	2490	15,3	172	163		
			700	3582	3340	21,7	162	154		
	122930/850H	5000	350	1938	1808	10,5	182	172		
			500	2709	2527	15,3	175	165		
			700	3634	3389	21,7	165	156		
SM270/270E66	122940/830H	3000	350	1812	1691	10,5	170	161	30,6	32,4
			500	2532	2362	15,3	163	155		
			700	3397	3168	21,7	154	146		
	122940/840H	4000	350	1910	1782	10,5	179	167		
			500	2670	2490	15,3	172	163		
			700	3582	3340	21,7	162	154		
	122940/850H	5000	350	1938	1808	10,5	182	172		
			500	2709	2527	15,3	175	165		
			700	3634	3389	21,7	165	156		

The mentioned data can have a 10% tolerance - Il dato indicato può avere una tolleranza del 10%.

Main features

- Combinable modules for an optimal, versatile design. Perfect light uniformity.
- Ideal for residential, office, retail and industrial lighting.
- SELV modules (V < 60 V). Suitable for NON-SELV applications.
- Extended lifetime > 80.000 h.
- High efficiency: up to 182 lm/W.
- Minimum colour tolerance: 3MacAdam (3SDCM).
- Push-in terminal blocks. Easy module fixing with screws.
- Suitable for emergency applications with TCI inverters.
- Only for professional use, not for final end user.

Caratteristiche principali

- Moduli combinabili per un design ottimale e versatile. Luce perfettamente uniforme.
- Moduli ideali per illuminazione residenziale, uffici, spazi commerciali e industriali.
- Moduli SELV (V < 60 V). Idonei per applicazioni NON SELV.
- Lifetime esteso > 80.000 h.
- Elevata efficienza: fino a 182 lm/W.
- Minima tolleranza di colore: 3MacAdam (3SDCM).
- Morsetti a innesto rapido. Fissaggio del modulo semplice mediante viti.
- Moduli alimentabili in emergenza con inverter TCI.
- Prodotto ad uso unicamente professionale. Non per impiego da parte dell'utente finale.



SMART series - Square modules

Technical features - Caratteristiche tecniche

SM250/250E66 (Weight/Peso 5,86 oz. / gr. 166 - Pcs/Pezzi 30)

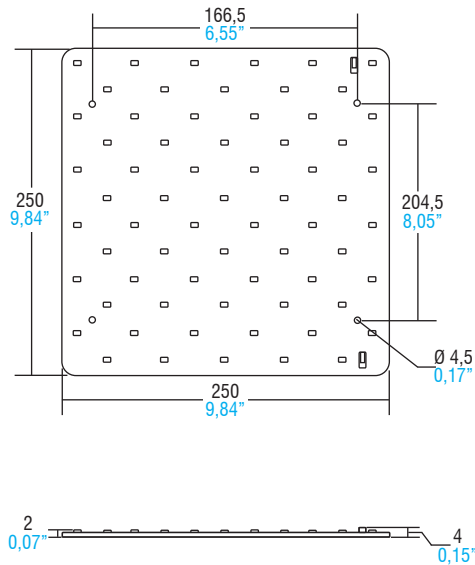

SM270/270E66 (Weight/Peso 8 oz. / gr. 227 - Pcs/Pezzi 30)

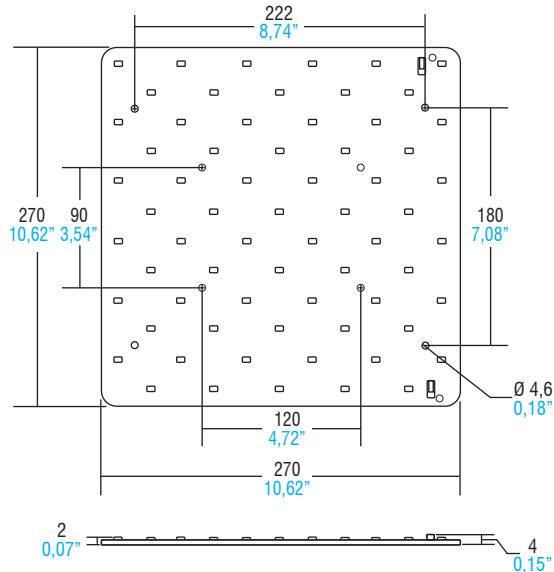

2.2

SPACE LIGHTING

Wiring - Cablaggio

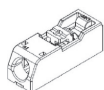
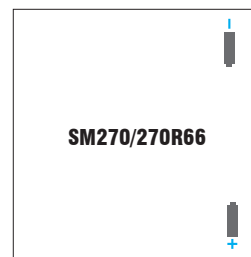
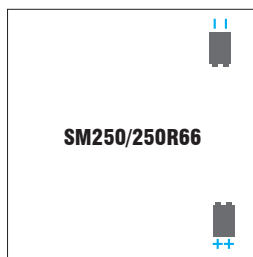

Insert/remove wires by slightly pressing on push-button. Inserire/rimuovere i cavi premendo leggermente sul pulsante.

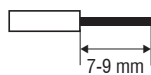

Solid conductor - Conduttore rigido	0,2...0,75 mm ² / 24...18 AWG
Fine-stranded conductor - Conduttore flessibile	0,2...0,75 mm ² / 24...18 AWG
Fine-stranded conductor with ferrule with plastic collar - Conduttore flessibile con boccola con isolamento in plastica	0,25...0,34 mm ²

Dissipation, assembly

A dissipation of the LED module might be required to guarantee the stated datas of brightness and lifetime. Please verify that the modules Tc does not exceed the maximum values as indicated in the table. It is recommended the use of all the holes for the fixing of the LED module or the use of thermoconductive pastes or adhesives. To avoid any damages to the LED module please use only rounded head screws and an additional plastic flat washer. If the LED modules are wired in parallel and a module fails, all the current flowing through the other LED module increases. This may reduce the lifetime of the LED module.

Handling and Cleaning

Don't give any shock to the LED modules nor store them in a dusty place. Avoid any contacts with any kind of fluid such as oil or organic solvents. It is recommended the use of IPA (isopropyl alcohol) as solvent to clean the LED modules. Before cleaning, a pre-test should be done to verify any possible damages to the LED module.

Static Electricity

Static electricity or surge voltage can damage the LED modules. Always wear anti ESD wrist band or anti ESD gloves when handling the LED modules.

Lifetime

The brightness value of a LED module according to 60.000/80.000 working hours is indicated by letter L. Letter B indicates the number of LEDs that keep the L value also after 60.000/80.000 working hours. TCI LED modules are guaranteed L80B20. In other words the 80% of the LEDs will have 80% or higher rendering after 60.000/80.000 working hours.

Dissipazione e assemblaggio

Per garantire i dati di luminosità e durata indicati può essere necessaria una dissipazione del modulo LED. Verificare che la Tc del modulo non superi i valori massimi indicati nella tabella. Si consiglia l'utilizzo di tutti i fori previsti per il fissaggio del modulo LED o l'utilizzo di pasta o adesivi termoconduttivi. Per non danneggiare i moduli LED utilizzare soltanto viti a testa arrotondata e rondelle plastiche piatte. Se i moduli LED sono collegati in parallelo e un modulo si danneggia, tutta la corrente che passa nell'altro modulo LED aumenta. Questo potrebbe ridurre il lifetime del modulo LED.

Uso e pulizia

Non procurare shock ai moduli LED e conservarli in luogo non polveroso. Evitare il contatto con qualsiasi tipo di fluido, come olio o solventi organici. Si raccomanda l'uso di IPA (alcol isopropilico) quale solvente per la pulizia dei moduli LED. Prima di procedere con la pulizia, dovrebbe essere effettuato un pre-test per accertare potenziali danni al modulo LED.

Elettricità statica

L'elettricità statica o le tensioni di rete possono danneggiare i moduli LED. Indossare un braccialetto ESD o guanti ESD durante l'uso dei moduli LED.

Lifetime

Il valore di luminosità di un modulo LED in base a 60.000/80.000 ore di funzionamento è indicato dalla lettera L. La lettera B indica invece il numero dei LED che rispetteranno il valore L dopo 60.000/80.000 ore di funzionamento. I moduli LED TCI sono garantiti L80B20, che significa che l'80% dei LED avrà una resa pari o superiore all'80% dopo 60.000/80.000 ore di utilizzo.

TCI LED modules are not equipped against mains spikes, overloads and short circuits. The use is guaranteed in combination with TCI drivers. I moduli LED TCI non sono protetti contro extra tensioni, sovraccarichi e cortocircuiti. L'utilizzo è garantito in combinazione con driver TCI.

For additional technical informations please visit our website: www.tci.it