

# MINI JOLLY DALI 20

**Direct current dimmable electronic drivers with DIP-SWITCH**  
**Alimentatori elettronici regolabili in corrente continua con DIP-SWITCH**

Made in Italy



DC MINI JOLLY DALI



DC MINI JOLLY DALI BI

3.1.2

Dimmable multipower drivers - Compact case - DALI  
 Alimentatori multipotenza regolabili - Formato compatto - DALI

**Rated Voltage**  
**Tensione Nominale**

110 ÷ 127 V <sup>(2)</sup>  
 220 ÷ 240 V

**Frequency**  
**Frequenza**

50-60 Hz

**AC Operation range**  
**Tensione di utilizzo AC**

99 ÷ 264 V

**DC Operation range**  
**Tensione di utilizzo DC**

(see page info15)  
 176 ÷ 280 V

**Power - Potenza**

1 ÷ 20 W

**iTHD**

≤ 10% <sup>(1)</sup>

**Stand by power**

≤ 0,5 W

**Output current ripple**

≤ 3% <sup>(1)</sup>

**Standards compliance**

CSA C22.2 no. 223 <sup>(2)</sup>

EN 55015

EN 61000-3-2

EN 61000-3-3

EN 61347-1

EN 61347-2-13

EN 61547

EN 62384

EN 62386-101

EN 62386-102

EN 62386-207

UL 1310 <sup>(2)</sup>

VDE 0710-T14

**Max. pcs for CB B16A**

(see page info17)

50 pcs

**In rush current**

5A 50μsec



Article Articolo	Code Codice	Dimming type	P out W	V out DC <sup>(1)</sup>	I out DC	U out V	ta °C	tc °C	λ max. Power Factor	η max. Efficiency <sup>(1)</sup>	
DC MINI JOLLY DALI <sup>(8)</sup>	125403 <sup>(4)</sup> 151403 <sup>(5)(7)</sup>	AM/PWM AM	Constant current output - Uscita in corrente costante <sup>(4)(5)</sup>				55	-25... +45	75	0,95 C	> 87 %
			12 (12 <sup>(2)</sup> )	15...49	250 mA cost.						
			17 (15 <sup>(2)</sup> )	10...49	350 mA cost.						
DC MINI JOLLY DALI BI	125403BI <sup>(4)</sup> 151403BI <sup>(5)</sup>	AM/PWM AM	19 (15 <sup>(2)</sup> )	5...49	400 mA cost.						
			20 (15 <sup>(2)</sup> )	5...45	450 mA cost.						
			20 (15 <sup>(2)</sup> )	5...40	500 mA cost.						
			20 (15 <sup>(2)</sup> )	3...36	550 mA cost.						
			20 (15 <sup>(2)</sup> )	3...33	600 mA cost.						
			20 (15 <sup>(2)</sup> )	3...28	700 mA cost.						
			Constant voltage output - Uscita in tensione costante <sup>(4)</sup>								
16 (15 <sup>(2)</sup> )	24 cost.	700 mA max.									

<sup>(1)</sup> Referred to V<sub>m</sub> = 230 V, 100% load - Riferito a V<sub>m</sub> = 230 V, carico 100%

<sup>(4)</sup> 125403BIS - 151403BIS - 125403BIBIS - 151403BIBIS:  
 order codes for BIS marked products - codici di ordine per i prodotti marchiati BIS

Light output level in DC operation: Factory default 100% EoFi=1

Livello di emissione luminosa in funzionamento DC: Impostazioni di fabbrica 100% EoFi=1

## Features

- Multipower driver supplied with dip-switch for the selection of the output current.
- IP20 independent driver, for indoor use.
- Class II protection against electric shock for direct or indirect contact.
- Driver for built-in use (DC MINI JOLLY DALI BI).
- It can be used for lighting equipment in protection class I and II (DC MINI JOLLY DALI BI).
- IP00, creepage distances and clearances rely on the final application according to IEC/EN 60598-1 (DC MINI JOLLY DALI BI).
- Active Power Factor Corrector.
- Analogical input (NTC) for thermal sensor connection.
- Current regulation ±5 % including temperature variations.
- Input and output terminal blocks on the same side (wire cross-section up to 1,5 mm<sup>2</sup> / AWG15).
- Clamping screws on primary and secondary circuits for cables with diameter: PRI 5-8 mm / SEC 3-5 mm.
- Protections:
  - against overheating and short circuits;
  - against mains voltage spikes;
  - against overloads.
- Thermal protection = C.5.a.

## Caratteristiche

- Alimentatore multipotenza fornito di dip-switch per la selezione della corrente in uscita.
- Alimentatore indipendente IP20, per uso interno.
- Protetto in classe II contro le scosse elettriche per contatti diretti e indiretti.
- Alimentatore da incorporare (DC MINI JOLLY DALI BI).
- Utilizzabile per apparecchi di illuminazione in classe di protezione I e II (DC MINI JOLLY DALI BI).
- IP00, le distanze di sicurezza sono demandate all'applicazione finale, in accordo alla IEC/EN 60598-1 (DC MINI JOLLY DALI BI).
- PFC attivo.
- Entrata analogica (NTC) per connessione sensore termico.
- Corrente regolata ±5 % incluse variazioni di temperatura.
- Morsetti di entrata e uscita sullo stesso lato (sezione cavo fino a 1,5 mm<sup>2</sup> / AWG15).
- Serracavo su primario e secondario per cavi di diametro: PRI 5-8 mm / SEC 3-5 mm.
- Protezioni:
  - termica e cortocircuito;
  - contro le extra-tensioni di rete;
  - contro i sovraccarichi.
- Protezione termica = C.5.a.

**Direct current dimmable electronic drivers with DIP-SWITCH**  
**Alimentatori elettronici regolabili in corrente continua con DIP-SWITCH**

Made in Italy

**IP 20** **SCREW FIXING** **Ø55** **2.17"** Weight - Peso gr. 106 / 3,7 oz.  
Pcs - Pezzi 50



**BUILT-IN** **SCREW FIXING** Weight - Peso gr. 94 / 3,3 oz.  
Pcs - Pezzi 50

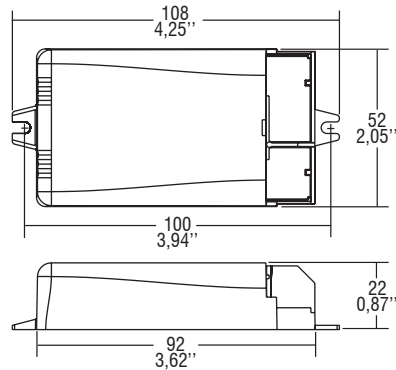

**Wiring diagram - Schema di collegamento** (Max. LED distance on page info8 - Massima distanza LED a pagina info8)

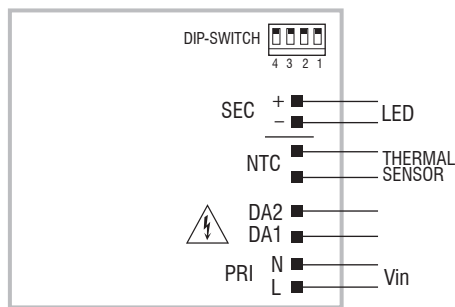

DALI diagram - Collegamento DALI

**Operation Mode**

- Features DALI dimming (0/0,5 - 100 %):
  - memory function for sets or light groups;
  - recall of stored functions;
  - compatible with standard DALI interfaces.
- <sup>(4)</sup> **Default dimming AM+PWM:** 1-25% PWM 2 kHz+25-100% AM.
- <sup>(4)</sup> **Full PWM dimming** (240 Hz - 1-100%) available by short circuit of NTC port during switch on of the driver. Same operation to reset to AM+PWM.
- <sup>(6)</sup> **Full AM DIMMING:** 1 - 100%.

For additional details for regulations see pages info12-14.

**Modalità di funzionamento**

- Caratteristiche della regolazione DALI (0/0,5 - 100 %):
  - funzione di memoria per scenari o gruppi luminosi;
  - richiamo di funzioni memorizzate;
  - compatibilità con interfacce DALI standard.
- <sup>(4)</sup> **Regolazione default AM+PWM:** 1-25% PWM 2 kHz+25-100% AM.
- <sup>(4)</sup> **Regolazione solo PWM** (240 Hz - 1-100%) attuabile tramite corto su porta NTC durante l'accensione dell'alimentatore. Reset a AM+PWM nello stesso modo.
- <sup>(6)</sup> **Regolazione solo AM:** 1 - 100%.

Per ulteriori dettagli sulle regolazioni vedi pagine info12-14.

**3.1.2**

Dimmable multipower drivers - Compact case - DALI  
Alimentatori multipotenza regolabili - Formato compatto - DALI