

MINI JOLLY DALI IPR2 - 30

Direct current dimmable electronic drivers
Alimentatori elettronici regolabili in corrente continua

Made in Italy 

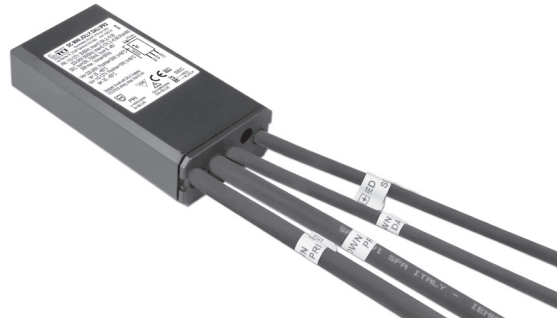
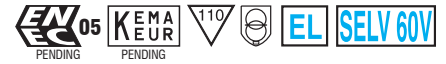

DIM-TO-WARM



Rated Voltage
Tensione Nominale
 110 ÷ 127 V ⁽²⁾
 220 ÷ 240 V

Article Articolo	Code Codice	INPUT LOOPING	P out W	V out DC ⁽¹⁾	I out DC	Default I out DC	U out V	ta °C	tc °C	λ max. Power Factor	η max. Efficiency ⁽¹⁾
DC MINI JOLLY DALI IPR2	152010	-	1...30 (1...15 ⁽²⁾)	2...49	250...700 mA cost.	250 mA	60	-40...+60	80 ⁽²⁾ 90	0,95	> 88
DC MINI JOLLY DALI IPR2 LO	152012	✓									

Frequency
Frequenza
 50-60 Hz

AC Operation range
Tensione di utilizzo AC
 99 ÷ 264 V

DC Operation range
Tensione di utilizzo DC
 (see page info15)
 DC 170 ÷ 276 V

Power
Potenza
 1 ÷ 30 W

Output current ripple
 ≤ 3% ⁽¹⁾

Standards compliance
 EN 50172 (VDE 0108)
 EN 55015
 EN 61000-3-2
 EN 61000-3-3
 EN 61347-1
 EN 61347-2-13
 EN 61547
 EN 62384

Max. pcs for CB B16A
 (see page info17)
 50 pcs

In rush current
 5A 50μsec

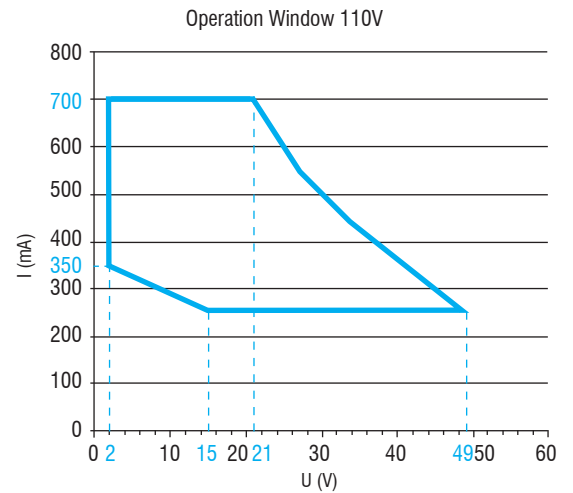
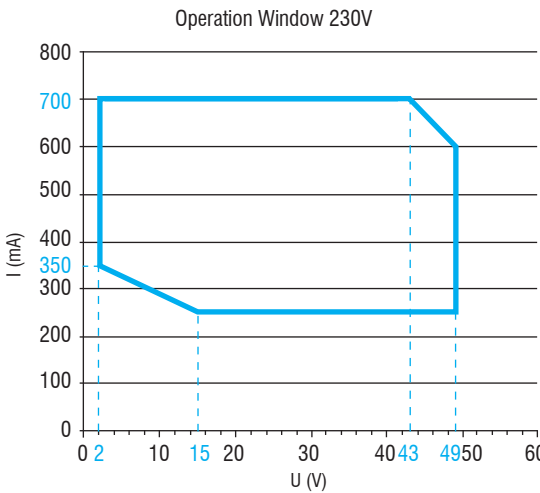

Features

- Ultra high input spikes protection up to 4kV (see datasheet).
- IP68 independent driver.
- Class II protection against electric shock for direct or indirect contact.
- Supplied with 400 mm cables on primary and secondary circuit for connection.
- Active Power Factor Corrector.
- Current regulation ±5 % including temperature variations.
- Protections:
 - against overheating and short circuits;
 - against mains voltage spikes;
 - against overloads.
- Thermal protection = C.5.a.

Caratteristiche

- Elevata protezione contro spike di rete fino a 4kV (vedi datasheet).
- Alimentatore indipendente IP68.
- Protetto in classe II contro le scosse elettriche per contatti diretti e indiretti.
- Fornito di cavi da 400 mm su primario e secondario per il collegamento.
- PFC attivo.
- Corrente regolata ±5 % incluse variazioni di temperatura.
- Protezioni:
 - termica e cortocircuito;
 - contro le extra-tensioni di rete;
 - contro i sovraccarichi.
- Protezione termica = C.5.a.



The data shown are preliminary and may change - I dati riportati sono preliminari e potrebbero subire variazioni

Direct current dimmable electronic drivers Alimentatori elettronici regolabili in corrente continua

Made in Italy

CASE
IP 68 **SCREW FIXING** Ø60 2.36" Weight - Peso gr. 250 / 9 oz.
 Pcs - Pezzi -

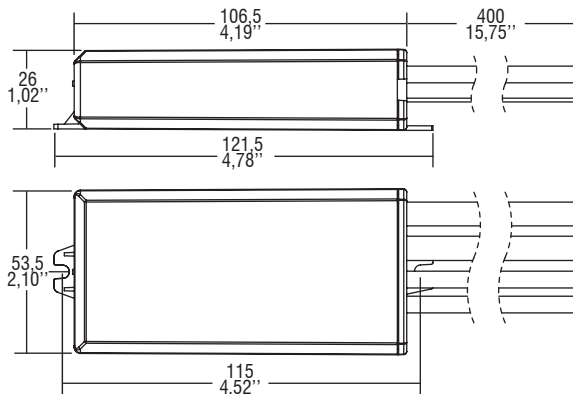

Wiring diagram - Schema di collegamento (Max. LED distance on page info8 - Massima distanza LED a pagina info8)

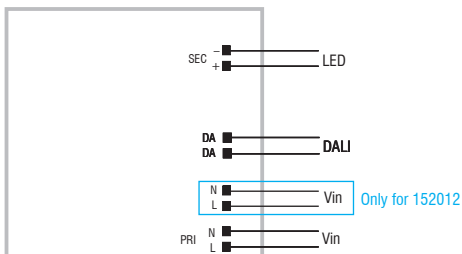

DALI diagram - Collegamento DALI

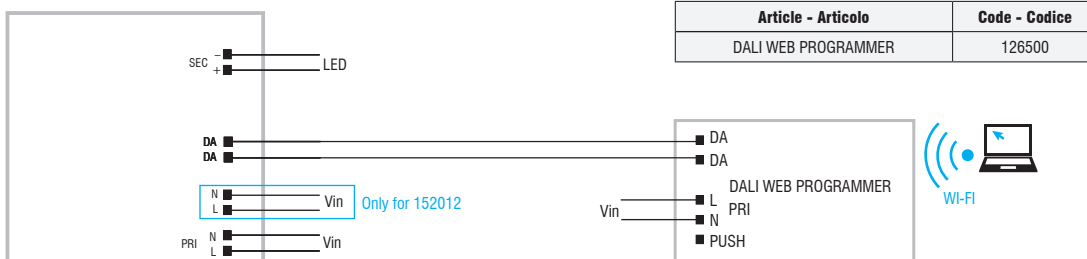

Programming via DALI - Programmazione tramite DALI

Operation Mode

- Light regulation 0/1 - 100 % by means of DALI.
- ⁽³⁾ Designed to work with DALI-2 systems.
- ⁽³⁾ AOC (Adjustable Output Current) via DALI port with DALI PROGRAMMER.
- **Full AM DIMMING: 1 - 100%.**
- Features DALI dimming:
 - memory function for sets or light groups;
 - recall of stored functions;
 - compatible with standard DALI interfaces.

For additional details for regulations see pages info12-14.

Modalità di funzionamento

- Regolazione della luminosità 0/1 - 100 % mediante DALI.
- ⁽³⁾ Progettato per funzionare con sistemi DALI-2.
- ⁽³⁾ AOC (Adjustable Output Current) attraverso porta DALI con DALI PROGRAMMER.
- **Regolazione solo AM: 1 - 100%.**
- Caratteristiche della regolazione DALI:
 - funzione di memoria per scenari o gruppi luminosi;
 - richiamo di funzioni memorizzate;
 - compatibilità con interfacce DALI standard.

Per ulteriori dettagli sulle regolazioni vedi pagine info12-14.

6.
IP rated drivers
Alimentatori protetti IP