

Direct current dimmable electronic drivers
Alimentatori elettronici regolabili in corrente continua



DIM-TO-WARM



Article - Articolo	Code - Codice
FPD PROGRAMMING TOOL	127098
LINK TO DOWNLOAD PROGRAMMING SOFTWARE LINK PER SCARICARE SOFTWARE DI PROGRAMMAZIONE www.tci.it/TCI_tools/FPD_PROGRAMMING_TOOL_127098.zip	



⁽¹⁾ Referred to $V_{in} = 230$ V, 100% load
Riferito a $V_{in} = 230$ V, carico 100%

4.4

High power programmable

Rated Voltage
Tensione Nominale
110 ÷ 277 V

Frequency
Frequenza
50-60 Hz

AC Operation range
Tensione di utilizzo AC
99 ÷ 305 V

Power - Potenza
18 ÷ 320 W

iTHD
≤ 20% ⁽¹⁾

Stand by power
≤ 0,5 W

Output current ripple
≤ 5% ⁽¹⁾

Standards compliance

EN 55015
EN 61000-3-2
EN 61000-3-3
EN 61347-1
EN 61347-2-13
EN 61547
VDE 0710-T14

Max. pcs for CB B16A

(see page info17)
75W: 8 pcs
100W: 8 pcs
150W: 5 pcs
200W: 4 pcs
250W: 2 pcs
320W: 3 pcs

In rush current

75W: 65A 250μsec
100W: 65A 250μsec
150W: 110A 250μsec
200W: 180A 200μsec
250W: 280A 150μsec
320W: 180A 250μsec

Power Factor

75W: λ for Po=39W ⁽²⁾
100W: λ for Po=34W ⁽²⁾
150W: λ for Po=55W ⁽²⁾
200W: λ for Po=53W ⁽²⁾
250W: λ for Po=76W ⁽²⁾
320W: λ for Po=67W ⁽²⁾

Article Articolo	Code Codice	P out W	V out DC ⁽¹⁾	I out DC	Default I out DC	U out V	ta °C	tc °C	λ max. Power Factor ⁽²⁾	η max. Efficiency ⁽¹⁾
VEGA 75/500-1400 FPD IP67	127804	18...75	36...107	500...1400 mA cost.	700 mA	120	-40...+60	85	0,95	> 92
VEGA 100/600-1400 FPD IP67	127805	28...100	47...143	600...1400 mA cost.	700 mA	150	-40...+60	85	0,95	> 92
VEGA 150/600-1400 FPD IP67	127806	43...150	72...214	600...1400 mA cost.	700 mA	250	-40...+60	85	0,95	> 93
VEGA 200/600-1400 FPD IP67	127807	45...200	75...190	600...1400 mA cost.	1050 mA	230	-40...+60	90	0,95	> 94
VEGA 250/600-1400 FPD IP67	127808	54...250	90...238	600...1400 mA cost.	1050 mA	250	-40...+55	90	0,95	> 94
VEGA 320/700-2100 FPD IP67	127809	63...320	90...225	700...2100 mA cost.	1400 mA	250	-40...+50	90	0,95	> 94

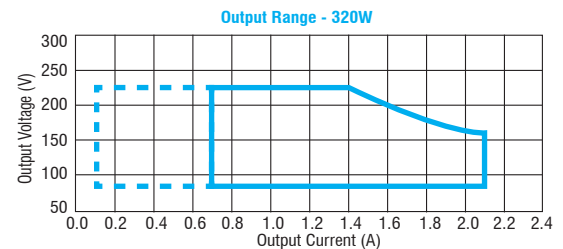
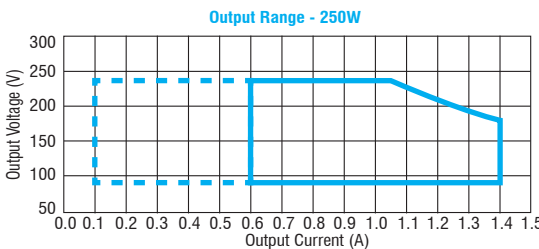
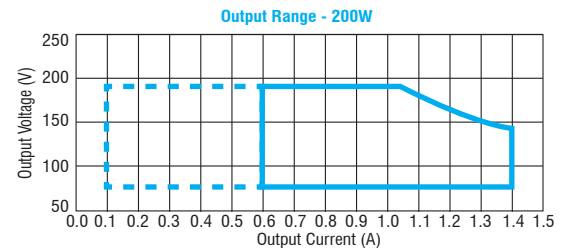
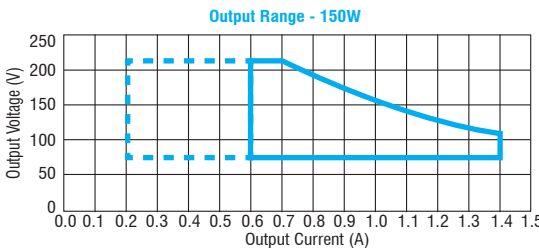
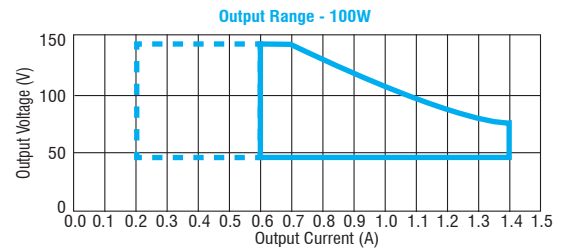
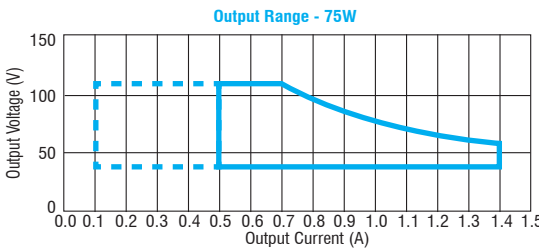

— Programmed Range - - - - - 1-10V DIM Range

Features

- **Multipower driver with programmable current.**
- Independent driver with case IP67 (see page info7 for the correct connection of connecting leads).
- Class I protection against electric shock for direct or indirect contact.
- Active Power Factor Corrector.
- Auxiliary output 12 V max. 50 mA.
- Analogical input for thermal sensor connection.
- Current regulation ±10 % including temperature variations.
- Supplied with connecting leads on primary and secondary circuits for connection.
- Protections:
 - against overheating and short circuits;
 - against mains voltage spikes;
 - against overloads.
- Thermal protection = C.5.a.

Caratteristiche

- **Alimentatore multipotenza con correnti programmabili.**
- Alimentatore indipendente con case IP67 (vedi pagina info7 per il corretto collegamento dei cavi di connessione).
- Protetto in classe I contro le scosse elettriche per contatti diretti e indiretti.
- PFC attivo.
- Uscita ausiliare 12 V max. 50 mA.
- Entrata analogica per sensore termico.
- Corrente regolata ±10 % incluse variazioni di temperatura.
- Fornito di cavi di connessione su primario e secondario per il collegamento.
- Protezioni:
 - termica e cortocircuito;
 - contro le extra-tensioni di rete;
 - contro i sovraccarichi.
- Protezione termica = C.5.a.

Direct current dimmable electronic drivers
Alimentatori elettronici regolabili in corrente continua

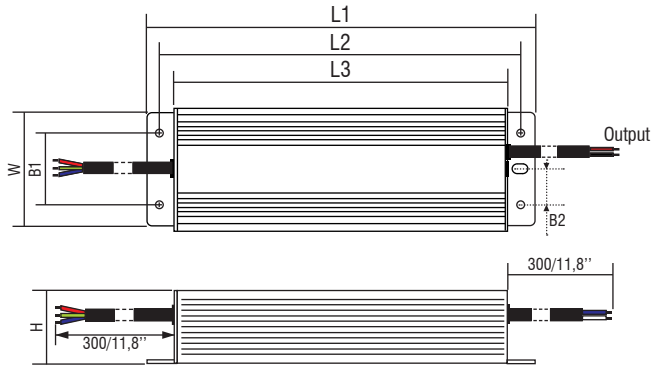

Article Articolo	Dimensions - Dimensioni							Weight - Peso
	L1	L2	L3	W	H	B1	B2	
VEGA 75/500-1400 FPD IP67	174	165	157	68	37	37	18	gr. 874 / 30,8 oz.
VEGA 100/600-1400 FPD IP67	174	165	157	68	37	37	18	gr. 899 / 31,7 oz.
VEGA 150/600-1400 FPD IP67	220	211	203	68	37	37	18	gr. 1152 / 40,7 oz.
VEGA 200/600-1400 FPD IP67	240	231	223	68	37	37	18	gr. 1304 / 46 oz.
VEGA 250/600-1400 FPD IP67	240	231	223	68	37	37	18	gr. 1311 / 46,3 oz.
VEGA 320/700-2100 FPD IP67	240	222	211	100	38	37	18	gr. 1774 / 62,6 oz.

Wiring diagrams - Schemi di collegamento (Max. LED distance at page info8 - Massima distanza LED a pagina info8)

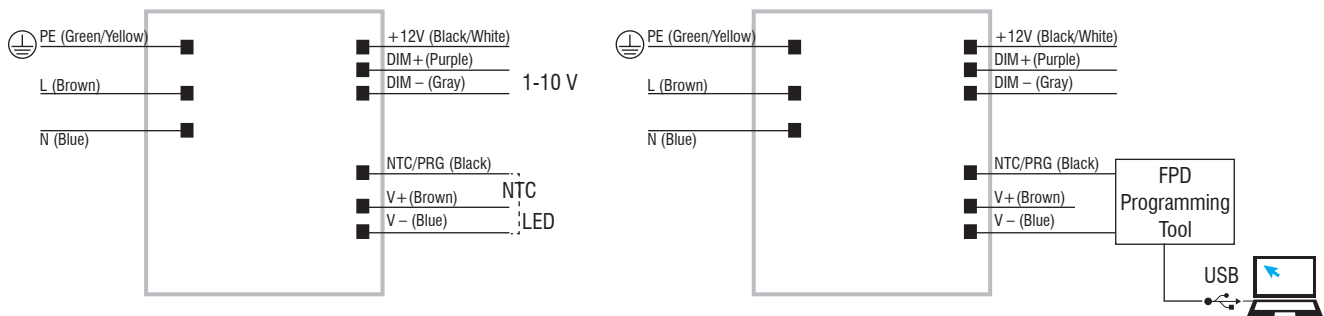

Operation Mode

- **FULL PROGRAMMABLE (FPD)** devices allow the user to set different parameters without need of switching on the product.
- The main available features are: **CURRENT** setting (AOC step 1 mA), **MIDNIGHT** functions, **NTC**, **CLO** (Constant Light Output), **1...10 V** dimming (I=0,25 mA).
- The **FULL PROGRAMMABLE (FPD)** functions can be set with the **FPD PROGRAMMING TOOL** interface through **NTC/V-** port.
- Light regulation: 10-100% (minimum dimming current 100 mA).
- Dimming method is linear.

For additional details for regulations see pages info12-14.

Modalità di funzionamento

- I dispositivi **FULL PROGRAMMABLE (FPD)** permettono all'utente di impostare diversi parametri senza la necessità di accendere il prodotto.
- Le principali caratteristiche disponibili sono: settaggio della **CORRENTE** (AOC step 1 mA), funzioni **MIDNIGHT**, **NTC**, **CLO** (Constant Light Output), dimmerazione **1...10 V** (I=0,25 mA).
- Le funzioni **FULL PROGRAMMABLE (FPD)** possono essere impostate con l'interfaccia **FPD PROGRAMMING TOOL** tramite porta **NTC/V-**.
- Regolazione della luminosità: 10-100% (corrente minima in regolazione 100 mA).
- La dimmerazione è di tipo lineare.

Per ulteriori dettagli sulle regolazioni vedi pagine info12-14.