

Direct current electronic drivers with DIP-SWITCH
Alimentatori elettronici in corrente continua con DIP-SWITCH

Made in Italy

constant CURRENT constant VOLTAGE

EN 05 KEMA EUR KEMA EMC SAA-142180-EA 110 M M SELV 60V

RIPPLE FREE



2.1

Multipower DIP-SWITCH drivers - Compact case
Alimentatori multipotenza con DIP-SWITCH - Formato compatto

ACTIVE PFC DIP-SWITCH 1-2kV DIFF. 2kV COMM. LOOPING COOKER HOOD SAFETY PROTECTIONS

Rated Voltage
Tensione Nominale
220 ÷ 240 V

Frequency
Frequenza
50/60 Hz

AC Operation range
Tensione di utilizzo AC
198 ÷ 264 V

DC Operation range
Tensione di utilizzo DC
(see page info15)
176 ÷ 264 V

Article Articolo	Code Codice	P out W	V out DC	I out DC	V out max.	ta °C	tc °C	λ max. Power Factor	η max. Efficiency ⁽¹⁾					
DC WOLF MP	122252	Constant current output - Uscita in corrente costante					70		0,97	>85				
		17	2...47	350 mA cost.	56	-25... +50								
		24	2...47	500 mA cost.										
		25	2...47	550 mA cost.										
		32	2...46	700 mA cost.		-25... +45								
		Constant voltage output - Uscita in tensione costante												
		10	12 cost.	820 mA max.	-	-25... +50								
		20	24 cost.	810 mA max.	-									
		22	28 cost.	780 mA max.	-									

⁽¹⁾ Referred to $V_{in} = 230$ V, 100% load - Riferito a $V_{in} = 230$ V, carico 100%

Power
Potenza
1 ÷ 32 W

IP 20 SCREW FIXING 056 2,20" Weight - Peso:
gr. 185 / 6,52 oz.
Pcs - Pezzi 40

Wiring diagram - Schema di collegamento
(Max. LED distance on page info8 - Massima
distanza LED a pagina info8)

Output current ripple
≤ 3% ⁽¹⁾

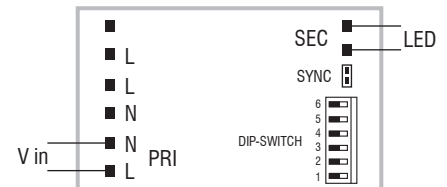
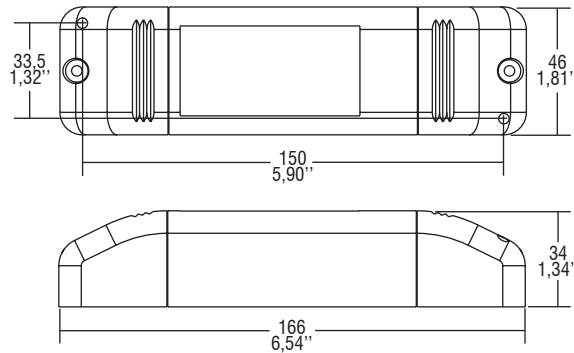

Reference Norms
Norme di riferimento
EN 50172 (VDE 0108)
EN 55015
EN 60335-1
EN 60598-2-22
EN 61000-3-2
EN 61000-3-3
EN 61347-1
EN 61347-2-13
EN 61547
EN 62384
VDE 0710-T14

Max. pcs for CB B16A
(see page info17)
50 pcs

In rush current
5A 50μsec

Features

- IP20 independent driver, for indoor use.
- Multipower driver supplied with dip-switch for the selection of the output current.
- Active Power Factor Corrector.
- Light regulation 0-100% by PWM signal (TTL).
- Class II protection against electric shock for direct or indirect contact.
- Current regulation ± 5 % including temperature variations.
- Supplied with terminal cover and cable retainer.
- Input and output terminal blocks on opposite sides (wire cross-section up to 2,5 mm² / AWG13).
- Double terminal blocks to loop other driver.
- Clamping screws on primary and secondary circuits for cables with diameter: min. 3 mm - max. 8 mm.
- Driver can be secured with slot for screws.
- Protections:
 - against overheating and short circuits;
 - against mains voltage spikes;
 - against overloads.
- Thermal protection = C.5.a.
- Double output impedance for use in household electrical appliances.

Caratteristiche

- Alimentatore indipendente IP20, per uso interno.
- Alimentatore multipotenza fornito di dip-switch per la selezione della corrente in uscita.
- PFC attivo.
- Regolazione della luminosità 0-100% mediante segnale PWM esterno (TTL).
- Protetto in classe II contro le scosse elettriche per contatti diretti e indiretti.
- Corrente regolata ± 5 % incluse variazioni di temperatura.
- Fornito di coprimorsetto e serracavo.
- Morsetti di entrata e uscita contrapposti (sezione cavo fino a 2,5 mm² / AWG13).
- Doppia morsettiera lato rete per rimando ad altro alimentatore.
- Serracavo su primario e secondario per cavi di diametro: min. 3 mm - max. 8 mm.
- Fissaggio dell'alimentatore tramite asole per viti.
- Protezioni:
 - termica e cortocircuito;
 - contro le extra-tensioni di rete;
 - contro i sovraccarichi.
- Protezione termica = C.5.a.
- Doppia impedenza d'uscita per l'utilizzo in apparecchi elettrodomestici.

7 YEARS WARRANTY 3% FAILURE RATE
10 YEARS WARRANTY 5% FAILURE RATE

PRODUCER'S LIABILITY
10 YEARS WARRANTY TO THE END USER ACCORDING TO THE EUROPEAN CONSUMER PROTECTION 2011