

Direct current dimmable electronic drivers Alimentatori elettronici regolabili in corrente continua

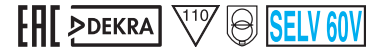

CVD 90W MD

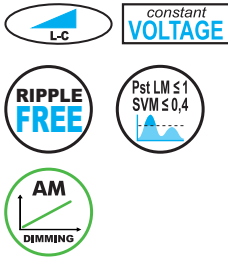

CVD 200W / 300W MD



**Rated Voltage
Tensione Nominale**
220 ÷ 240 V

**Frequency
Frequenza**
50-60 Hz

Power - Potenza
45 ÷ 80 W

iTHD
≤ 20% ⁽¹⁾

Output current ripple
≤ 3% ⁽¹⁾

Standards compliance
EN 55015
EN 61347-1
EN 61347-2-13
EN 61000-3-3
EN 61000-3-2

Max. pcs for CB B16A
(see page info17)
CVD 90W: 11 pcs
CVD 200W: 5 pcs
CVD 300W: 3 pcs

In rush current
CVD 90W: 86A 485μsec
CVD 200W: 110A 485μsec
CVD 300W: 116A 485μsec

Article Articolo	Code Codice	P out W	V out DC	I out DC	ta °C	tc °C	λ max. Power Factor	η max. Efficiency ⁽¹⁾
CVD 90W 24V MD	145093	20...90	24	3,75 A max.	-40...+40	80	0,95 ⁽²⁾	> 86 %
CVD 200W 24V MD	145094	40...200	24	8,33 A max.	-40...+40	80	0,95 ⁽³⁾	> 87 %
CVD 300W 24V MD	145095	60...300	24	12,5 A max.	-40...+40	85	0,95 ⁽⁴⁾	> 89 %

⁽¹⁾ Referred to $V_{in} = 230$ V, 100% load - Riferito a $V_{in} = 230$ V, carico 100%

⁽²⁾ Pout > 33 W

⁽³⁾ Pout > 113 W

⁽⁴⁾ Pout > 123 W

Accessories not supplied - Accessori non a corredo

Article - Articolo	Code - Codice
ETDU29 (12.2)	180426
ETD2E9 (12.2)	180427

Features

- Dimmable electronic driver with output voltage for LED modules.
- IP20 (45 W) and IP 66 (200 W / 300 W) independent driver, for indoor and outdoor use (see page info5).
- 90 W:
 - Class II protection against electric shock for direct or indirect contact.
 - Input and output terminal blocks on opposite sides.
 - Single terminal block on primary and secondary (wire cross-section up to 0,75 - 4 mm² / AWG18 - AWG11).
- 200 W / 300 W:
 - Class I protection against electric shock for direct or indirect contact.
 - Cables on primary and secondary circuits for connection.
 - If the input cable is damaged it can only be replaced by authorized personnel.
- Protections:
 - against overheating and short circuits;
 - against mains voltage spikes;
 - against overloads.
- Thermal protection = C.5.e.

Caratteristiche

- Alimentatore elettronico regolabile con uscita in tensione per moduli LED.
- Alimentatori indipendenti IP20 (90 W) e IP 66 (200 W / 300 W), per uso interno ed esterno (vedi pagina info5).
- 90 W:
 - Protetto in classe II contro le scosse elettriche per contatti diretti e indiretti.
 - Morsetti di entrata e uscita contrapposti.
 - Singola morsettiera su primario e secondario (sezione cavo fino a 0,75 - 4 mm² / AWG18 - AWG11).
- 200 W / 300 W:
 - Protetto in classe I contro le scosse elettriche per contatti diretti e indiretti.
 - Fornito di cavi su primario e secondario per il collegamento.
 - Se il cavo di rete è danneggiato deve essere sostituito da personale autorizzato.
- Protezioni:
 - termica e cortocircuito;
 - contro le extra-tensioni di rete;
 - contro i sovraccarichi.
- Protezione termica = C.5.e.

5.1.2

Constant voltage drivers - Compact case - Dimmable
Alimentatori a tensione costante - Formato compatto - Regolabili

Direct current dimmable electronic drivers
Alimentatori elettronici regolabili in corrente continua

IP 20 **SCREW FIXING** $\varnothing 80$ 3.15" Weight - Peso gr. 450 / 15,9 oz. Pcs - Pezzi - 20

CVD 90W MD

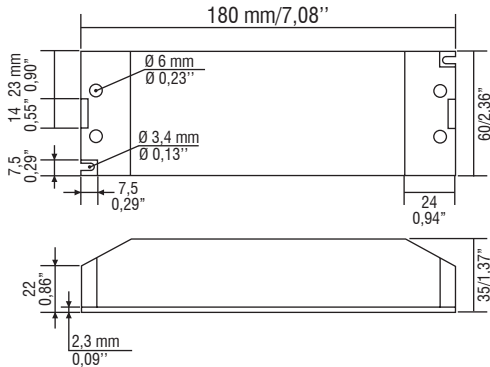

Wiring diagrams - Schemi di collegamento

(Max. LED distance at page info8 - Massima distanza LED a pagina info8)

CVD 90W MD

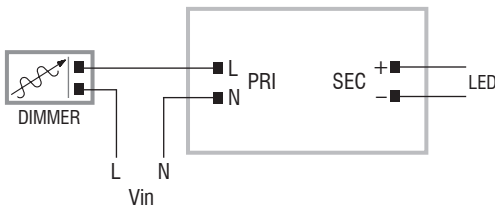

CVD 200W / 300W MD

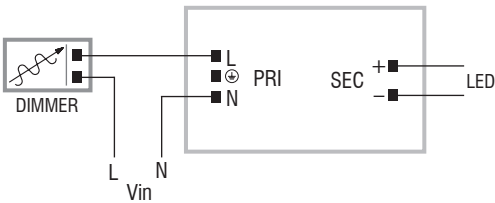

Derating curve - Curva di declassamento

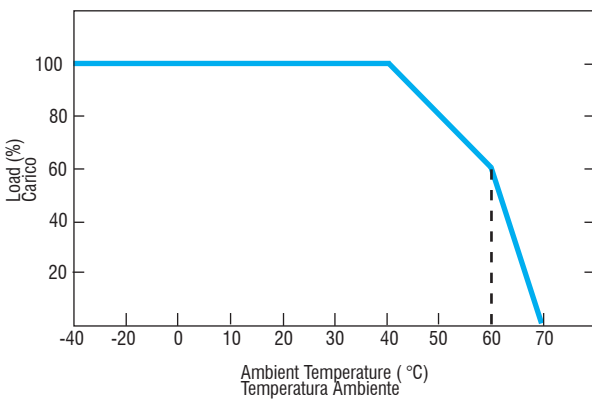

Operation Mode

- Regulating driver with "phase cut-off" dimmer IGBT and TRIAC.

IP 66 **SCREW FIXING**

CVD 200W / 300 W MD

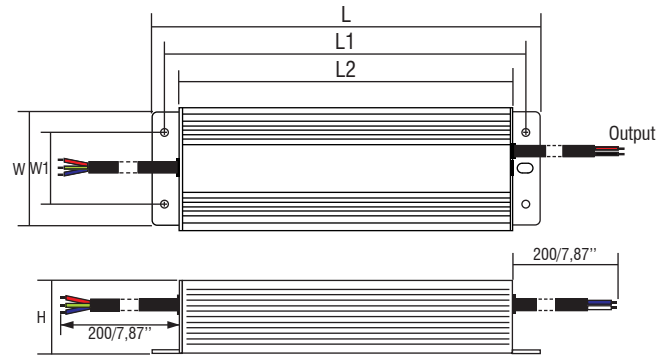

Article Articolo	Dimensions - Dimensioni						Weight Peso
	L	L1	L2	W	W1	H	
CVD 200W MD	256	244	238	78	43	47	gr. 1450 - 51,1 oz.
CVD 300W MD	276	264	252	78	43	47	gr. 1670 - 58,9 oz.

5.1.2

Constant voltage drivers - Compact case - Dimmable
 Alimentatori a tensione costante - Formato compatto - Regolabili

Modalità di funzionamento

- Alimentatore regolabile con dimmer a "taglio di fase" IGBT e TRIAC.