

INGRESSO

- Nominale: 110/240 Vac ^{-10/+10 %} 50/60Hz.
170...280Vdc con alimentazione di emergenza.
- Morsetti 1 x 0,2...1.5 mm².
- Serracavo per cavi D= 3...8mm
- Corrente massima: 0,45A.
- Fattore di potenza λ: 0.95 @ Pout >25W
- Armoniche corrente assorbita: secondo EN 61000-3-2.
- Inrush current: 10A 200uS.

USCITA

- Isolamento SELV.
- Morsetti 1 x 0,5...2.5 mm².
- Serracavo per cavi D= 3...8mm
- Selezione corrente e tensione di uscita tramite DIP switch (vedi tabella).
- Potenza massima e precisione di corrente
220/240VAC
25W @ 350mA ± 6% (10...70V)
31W @ 450mA ± 5% (10...70V)
35W @ 500mA ± 5% (2...70V)
38W @ 550mA ± 5% (2...69V)
40W @ 600mA ± 5% (2...68V)
50W @ 700mA ± 5% (2...68V)
52W @ 800mA ± 5% (2...66V)
60W @ 900mA ± 5% (2...66V)
63W @ 950mA ± 5% (2...66V)
65W @ 1050mA ± 5% (2...58V)
65W @ 1200mA ± 5% (2...54V)
- Potenza massima e precisione di corrente
110/120VAC
25W @ 350mA ± 6% (10...70V)
31W @ 450mA ± 5% (10...70V)
35W @ 500mA ± 5% (2...70V)
38W @ 550mA ± 5% (2...69V)
40W @ 600mA ± 5% (2...67V)
40W @ 700mA ± 5% (2...58V)
40W @ 800mA ± 5% (2...50V)
40W @ 900mA ± 5% (2...45V)
40W @ 950mA ± 5% (2...42V)
40W @ 1050mA ± 5% (2...38V)
40W @ 1200mA ± 5% (2...33V)
- Tensione in uscita massima: 95 VDC.
- Efficienza @ full load: 91%. 50% Load: 90%.
- Consumo senza carico: <1W.
- Uscita ausiliaria isolata 12V - 100mA max

REGOLAZIONE

- Tipo PWM comandata da segnale 1-10V, potenziometro 100K, pulsante o segnale DALI * **.
- Segnale 1-10V e potenziometro collegabile sul lato secondario (corrente fornita max 1.2 mA).

INPUT

- Nominal: 110/240 Vac ^{-10/+10 %} 50/60Hz.
170...280Vdc for emergency application.
- Terminal block for up to 1 x 0,2...1.5 mm².
- Strain relief for cables with D= 3...8mm.
- Max Input Current: 0,45A.
- Power factor λ: 0.95 @ Pout >25W.
- Harmonic content of mains current: according to EN 61000-3-2.
- Inrush current: 10A 200uS.

OUTPUT

- SELV insulation on output.
- Terminal block for up to 1 x 0,5...2.5 mm².
- Strain relief for cables with D= 3...8mm
- Selection of current and voltage output through Dip switch (See table)
- Max output power and current precision
220/240VAC
25W @ 350mA ± 6% (10...70V)
31W @ 450mA ± 5% (10...70V)
35W @ 500mA ± 5% (2...70V)
38W @ 550mA ± 5% (2...69V)
40W @ 600mA ± 5% (2...68V)
50W @ 700mA ± 5% (2...68V)
52W @ 800mA ± 5% (2...66V)
60W @ 900mA ± 5% (2...66V)
63W @ 950mA ± 5% (2...66V)
65W @ 1050mA ± 5% (2...58V)
65W @ 1200mA ± 5% (2...54V)
- Max output power and current precision
110/120VAC.
25W @ 350mA ± 6% (10...70V)
31W @ 450mA ± 5% (10...70V)
35W @ 500mA ± 5% (2...70V)
38W @ 550mA ± 5% (2...69V)
40W @ 600mA ± 5% (2...67V)
40W @ 700mA ± 5% (2...58V)
40W @ 800mA ± 5% (2...50V)
40W @ 900mA ± 5% (2...45V)
40W @ 950mA ± 5% (2...42V)
40W @ 1050mA ± 5% (2...38V)
40W @ 1200mA ± 5% (2...33V)
- Max. Output voltage: 95 VDC.
- Efficiency @ full load: 91%. 50% load: 90%.
- No load consumption: <1W.
- 12V isolated auxiliary output - 100mA max.

DIMMING

- PWM controlled by 1-10V signal, 100K potentiometer, pushbutton or DALI signal * **.
- Terminal block on the secondary side for 1-10V Signal or potentiometer(max source current 1.2 mA)

ENTE EMITTENTE: DT Compilato _____ Visto _____

- Pulsante collegabile su lato primario tra fase e morsetto dedicato (impedenza 170Kohm).
- Connettori per sincronizzazione più alimentatori (1 master + 9 slaves max).
- Possibilità selezione softstart ***.
- Connettore per collegamento NTC esterna per riduzione corrente carico: tensione intervento 3V: Resint 18K. (Vedi tabella).
- Connettore (Iset) per collegamento resistenza esterna per riduzione corrente carico (Vedi tabella).

PROTEZIONI

- All'ingresso, contro sovratensioni impulsive di rete (secondo EN 61547) fino a 3.5KV N-L , 4KV N-GND e 4KV L-GND.
- Protezione al corto circuito e al circuito aperto.
- Protezione al sovraccarico e di temperatura (C.5.a della EN 61347-1).

FILTRO ANTIDISTURBO EMI

- Secondo EN55015.

AMBIENTE

- Temp. ambiente: -25...50°C (45°C Pout>60W)
- tc = 80 °C.
- tc life 50000H = 73°C.

SICUREZZA

- Hi-pot test: 3.75 kV, 100% per 2 sec.

NORMATIVE

- EN 61347-1 ; EN 61347-2-13 ; EN 61547 ; EN 55015 ; EN 61000-3-2 ; EN62384 ; EN62386 DIN VDE 0710 teil 14; EN60598-2-22 ; UL8750 (UL1310) / EN50172
- KEMA KEUR / ENEC05 / UL.

DIMENSIONI

- L=129mm / B=76 mm / H = 30 mm.

- Terminal block on primary side for push button; (Impedance 170Kohm).
- Header for other power supplier synchronization (1master + 9 slaves max).
- Selectable Softstart ***.
- Terminal block for external NTC signal for load current reduction: trigger voltage 3V: Int Res. 18K (see table).
- Terminal block (Iset) for external resistor for load current reduction (see table).

PROTECTIONS

- Against input overvoltages from mains (according to EN61547) up to 3.5KV N-L , 4KV N-GND e 4KV L-GND.
- Against short circuit and open circuit.
- Thermal and overload protection (C.5.a EN 61347-1).

EMI

- According to EN55015.

AMBIENT

- Ambient temp.: -25...50 °C (45°C Pout>60W)
- tc = 80 °C.
- tc life 50000H = 73°C.

SAFETY

- Hi-pot test: 3.75 kV, 100% for 2 sec.

STANDARDS

- EN 61347-1 ; EN 61347-2-13 ; EN 61547 ; EN 55015 ; EN 61000-3-2 ; EN62384 ; EN62386 DIN VDE 0710 teil 14. EN60598-2-22 : UL8750 (UL1310) EN50172
- KEMA KEUR / ENEC05 / UL.

DIMENSIONS

- L=129mm / B=76 mm / H = 30 mm.

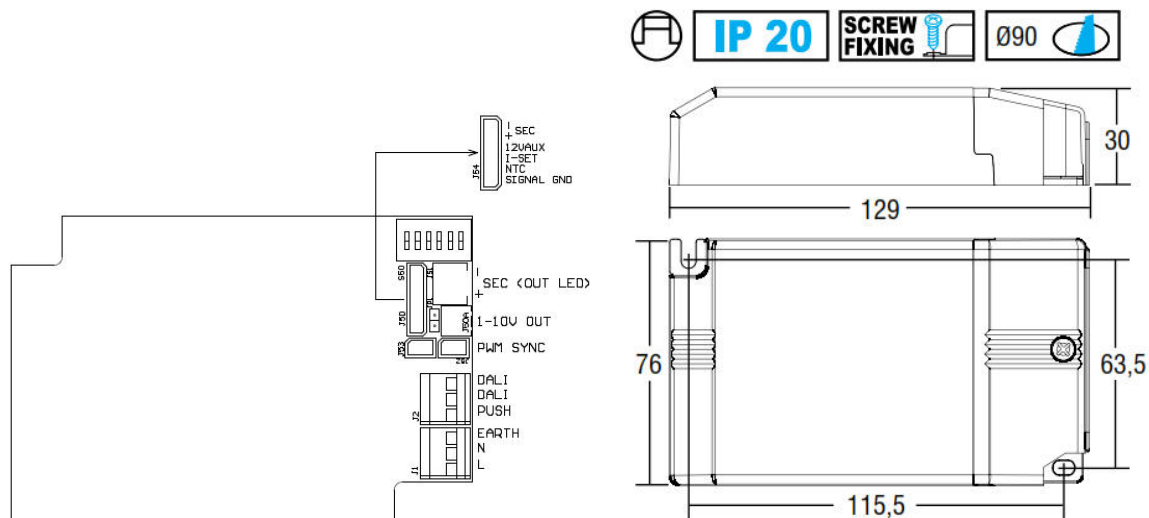

Valore NTC	Temperatura inizio intervento (3V Req= 26Kohm)	Temperatura spegnimento completo (2,2V Roff=15Kohm)
100K	55°C	72°C
150K	65°C	80°C
220K	75°C	90°C

Tabella intervento NTC esterna. Vedere specifica produttore di NTC

External NTC Table. See NTC manufacturer datasheet.

* Il pulsante deve essere collegato tra il connettore (Push) e la fase. L'utilizzo del pulsante inibisce l'uso del segnale 1-10V. Per tornare all'utilizzo del segnale 1-10V tenere il segnale minore di 0,5V per almeno 2 secondi.

Push button must be connected between the Terminal block (PUSH) and Phase. The use of push button inhibits the 1-10V signal. To reset keep the 1-10V signal below 0,5V for at least 2 secs.

** Sincronizzazione PUSH:

Se si utilizza più di un dispositivo con un singolo tasto PUSH, si può verificare un comportamento asincrono, il quale richiede una resincronizzazione manuale usando il metodo descritto. Si raccomanda di non controllare più di 4 dispositivi con un singolo tasto. Se questo risulta inaccettabile, utilizzare il cavo di sincronismo.

Un qualunque sistema di dimmerazione che non ha un modulo centrale di controllo (dato che ogni driver ha il suo proprio controllo) può generare un comportamento asincrono (es. bambini che giocano con il tasto). Il sistema è quindi fuori sincronismo, per esempio alcune lampade sono accese, altre spente o la direzione di dimmerazione differisce da lampada a lampada.

Metodo di resincronizzazione: quando i driver sono accesi, premere il tasto PUSH per più di 1 secondo (long PUSH) seguito da una pressione rapida minore di 1 secondo (short PUSH). Ora i dispositivi sono spenti, effettuare un long PUSH, il sistema è ora resincronizzato.

Massima lunghezza totale cavi PUSH: 15m.

PUSH Synchronisation:

If more than one device is operated with a single key during PUSH operation, asynchronous behaviour can occur, which will require manual resynchronisation using the method described. It is recommended not to control more than four devices using a single key.

Should this be unacceptable, a synchronisation cable will have to be used instead.

ENTE EMITTENTE: _____ Compilato: _____ Visto: _____

Any 1-key dimmer that does not feature a central control module (as each driver will have its own controls) can develop asynchronous behaviour (e.g. children might play with the key). The system will then be out of sync, i.e. some lamps will be on, others off or the dimming direction will differ from lamp to lamp.

Method of resynchronisation: when the drivers are switched on, press the PUSH key for more than one second (long PUSH) followed with a short push (<1s). Now the devices are switched off, do a long PUSH, the system will now be resynchronised. Total length of PUSH cables: 15m.

*** La selezione della funzione softstart avviene tenendo in cortocircuito il morsetto di PUSH con il morsetto di FASE nel momento dell'accensione dall'alimentatore.

To select the softstart function keep in shortcircuit PUSH terminal block with Phase terminal block at switch on.

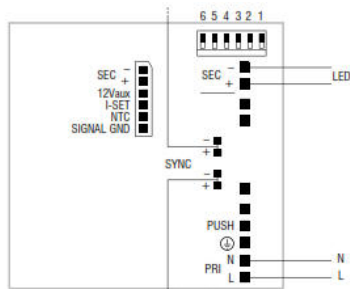

Max. 10 alimentatori in serie
 Max. 10 drivers in looping connection

PUSH diagram - Collegamento PUSH

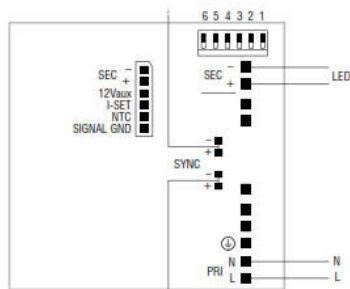

Max. 10 alimentatori in serie
 Max. 10 drivers in looping connection

1...10 V diagram - Collegamento 1...10 V

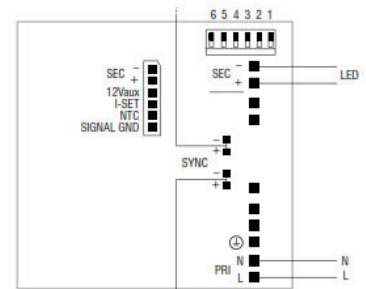

Max. 10 alimentatori in serie
 Max. 10 drivers in looping connection

DALI diagram - Collegamento DALI

TCI DC MAXI JOLLY DALI H/2
 Dimmable AC/DC P/S for LED
 MADE IN ITALY
 PRI: 110V~; 127V~; 50/60Hz; 220V~240V 0.50/60Hz
 $I_{max}=0.45^{**}-0.32^*A$; $\lambda (P>25W)=0.95$
 SEC: 65W max 350...1200mA (Vomax=95Vdc)
 according to the switches selection
 Vaux = 12V / 100mA max; NTC=see datasheet;
 $t_a = -25...+50^{\circ}C$ ($45^{\circ}C$ Pout=60W); $t_c=80^{\circ}C$
 Thermal protection; short circuit protection
 Short circuit 1...10V port for at least 2 sec to reset the device
 *76-283Vdc range x emerg. appl.; $I_{max}=0.41A$; PLUS mode excluded

*10V *27V	220V	SEC	6	5	4	3	2	1
25 W	25 W	350 mA	-	-	-	-	-	-
31 W	31 W	450 mA	ON	-	-	-	-	-
35 W	35 W	500 mA	-	ON	-	-	-	-
38 W	38 W	550 mA	-	-	ON	-	-	-
40 W	41 W	600 mA	-	-	-	ON	-	-
40 W	46 W	700 mA	-	ON	ON	-	-	-
40 W	52 W	800 mA	-	-	ON	ON	-	-
40 W	60 W	900 mA	ON	-	ON	ON	-	-
40 W	63 W	950 mA	-	-	ON	ON	ON	-
40 W	65 W	1050 mA	ON	ON	ON	ON	-	-
40 W	e5 W	1200 mA	ON	ON	ON	ON	ON	-
40 W	e5 W	98V	ON	ON	ON	ON	ON	ON

Before use, always check S50 d pswitch settings

CE DALI SELV

SEC wire prep. C, 0-2, 5 mm
 28-14 AWG
 3-7mm
 1...10V wire wrap: 0.2-1,5mm
 28-18 AWG
 4,5-5,5mm
 PRI / PUSH LEDA
 insulated wire wrap: 0.5-1,5mm
 23-18 AWG
 8-9mm

DA 1
 DA 2
 PUSH L
 PATENTED 1000125341

5 KEUR M M DA2: basic insulation to PRI circuit
 DA1: supplementary insulation to SELV circuit

ENTE EMITTENTE: _____ Compilato: _____ Visto: _____

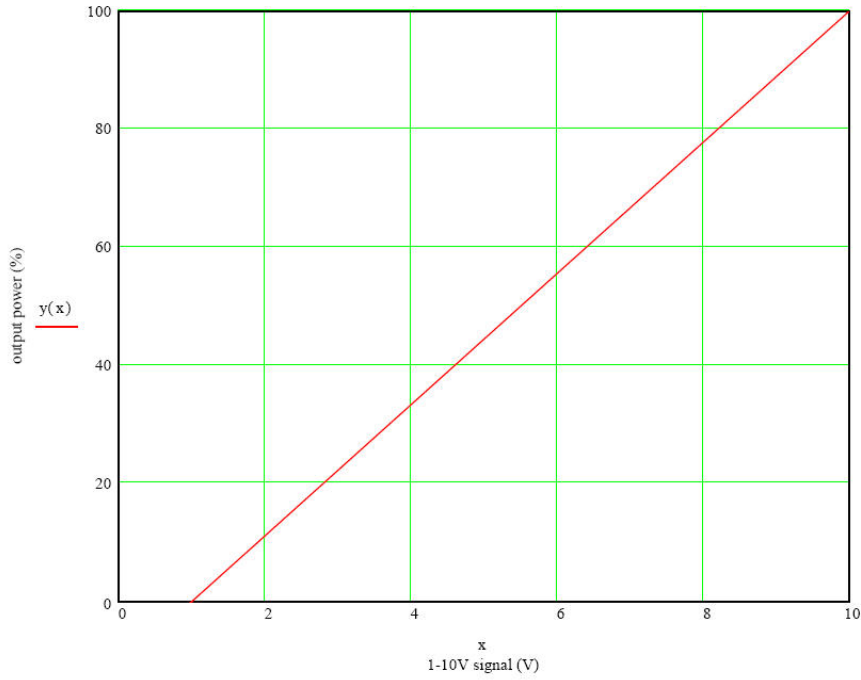

Output power vs 1-10V signal

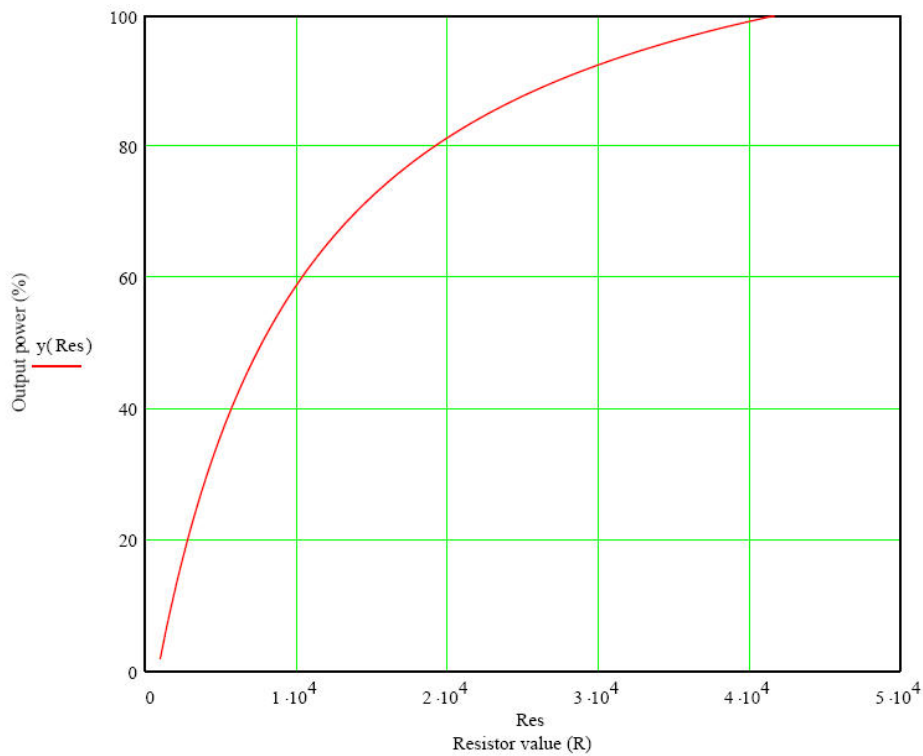

Output power vs 1-10V resistor

ENTE EMITTENTE: _____ Compilato: _____ Visto: _____



TCI S.r.l.
21047 SARONNO (VA) Via Parma,14
Tel. (02) 964.16.1 - FAX (02) 960.82.47

SPECIFICA TECNICA - TECHNICAL SPEC.
Alimentatore DC MAXI JOLLY DALI H/2
Dimmable LED AC/DC Power Supply Cod:127074

Data: 18-01-16

Pag 6/9

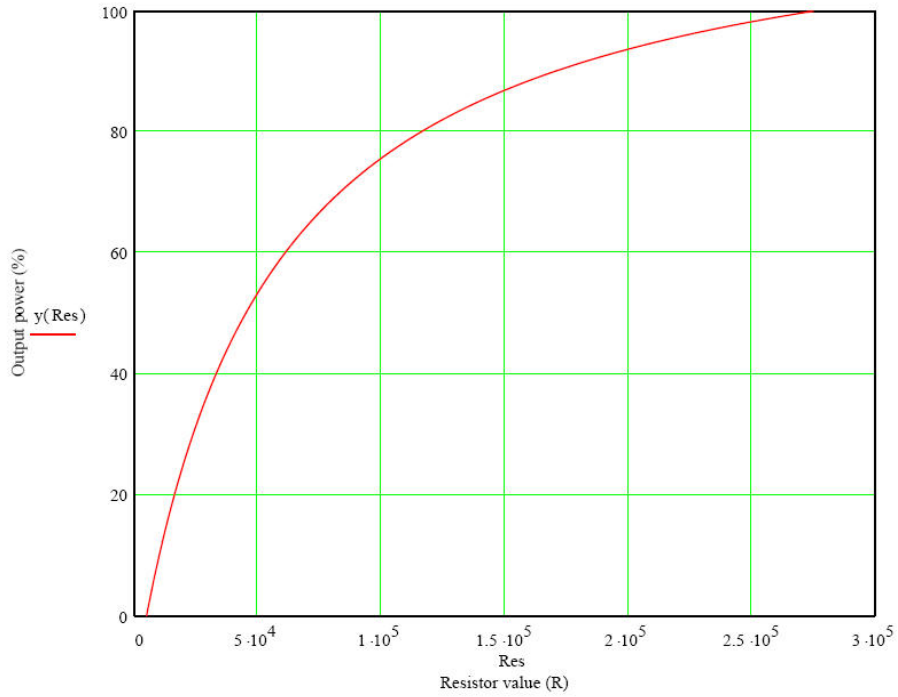

Output power vs Iset resistor

ENTE EMITTENTE: _____ Compilato: _____ Visto: _____

DALI Interface – supported commands

Com-	Command Name	Implemented / Reaction
–	DIRECT ARC POWER CONTROL	yes
0	OFF	yes
1	UP	yes
2	DOWN	yes
3	STEP UP	yes
4	STEP DOWN	yes
5	RECALL MAX LEVEL	yes
6	RECALL MIN LEVEL	yes
7	STEP DOWN AND OFF	yes
8	ON AND STEP UP	yes
9	ENABLE DAPC SEQUENCE	yes
16 – 31	GOTO SCENE	yes
32	RESET	yes
33	STORE ACTUAL LEVEL IN THE DTR	yes
42	STORE THE DTR AS MAX LEVEL	yes
43	STORE THE DTR AS MIN LEVEL	yes
44	STORE THE DTR AS SYSTEM FAILURE	yes
45	STORE THE DTR AS POWER ON LEVEL	yes
46	STORE THE DTR AS FADE TIME	yes
47	STORE THE DTR AS FADE RATE	yes
64 – 79	STORE THE DTR AS SCENE	yes
80 – 95	REMOVE FROM SCENE	yes
96 – 111	ADD TO GROUP	yes
112 – 127	REMOVE FROM GROUP	yes
128	STORE DTR AS SHORT ADDRESS	yes
129	ENABLE WRITE MEMORY	yes
144	QUERY STATUS	yes
145	QUERY CONTROL GEAR	yes
146	QUERY LAMP FAILURE	Yes****
147	QUERY LAMP POWER ON	yes
148	QUERY LIMIT ERROR	yes
149	QUERY RESET STATE	yes
150	QUERY MISSING SHORT ADDRESS	yes
151	QUERY VERSION NUMBER	yes
152	QUERY CONTENT DTR	yes
153	QUERY DEVICE TYPE	yes
154	QUERY PHYSICAL MINIMUM LEVEL	yes
155	QUERY POWER FAILURE	yes

ENTE EMITTENTE: _____ Compilato: _____ Visto: _____

Com-	Command Name	Implemented / Reaction
156	QUERY CONTENT DTR1	yes
157	QUERY CONTENT DTR2	yes
160	QUERY ACTUAL LEVEL	yes
161	QUERY MAX LEVEL	yes
162	QUERY MIN LEVEL	yes
163	QUERY POWER ON LEVEL	yes
164	QUERY SYSTEM FAILURE LEVEL	yes
165	QUERY FADE TIME/FADE RATE	yes
176 – 191	QUERY SCENE LEVEL (SCENES 0-15)	yes
192	QUERY GROUPS 0-7	yes
193	QUERY GROUPS 8-15	yes
194	QUERY RANDOM ADDRESS (H)	yes
195	QUERY RANDOM ADDRESS (M)	yes
196	QUERY RANDOM ADDRESS (L)	yes
197	READ MEMORY LOCATION	yes
224	REFERENCE SYSTEM POWER	No
225	ENABLE CURRENT PROTECTOR	No
226	DISABLE CURRENT PROTECTOR	No
227	SELECT DIMMING CURVE	yes
228	STORE DTR AS FAST FADE TIME	yes
229	---	NA
230	---	NA
231	---	NA
232	---	NA
233	---	NA
234	---	NA
235	---	NA
236	---	NA
237	QUERY GEAR TYPE	yes
238	QUERY DIMMING CURVE	yes
239	QUERY POSSIBLE OPERATING MODES	yes
240	QUERY FEATURES	yes
241	QUERY FAILURE STATUS	yes
242	QUERY SHORT CIRCUIT	no
243	QUERY OPEN CIRCUIT	no
244	QUERY LOAD DECREASE	no
245	QUERY LOAD INCREASE	no
246	QUERY CURRENT PROTECTOR ACTIVE	no
247	QUERY THERMAL SHUT DOWN	yes
248	QUERY THERMAL OVERLOAD	yes
249	QUERY REFERENCE RUNNING	no

ENTE EMITTENTE: _____ Compilato: _____ Visto: _____

Com-	Command Name	Implemented / Reaction
250	QUERY REFERENCE MEASUREMENT FAILED	no
251	QUERY CURRENT PROTECTOR ENABLED	no
252	QUERY OPERATING MODE	yes
253	QUERY FAST FADE TIME	yes
254	QUERY MIN FAST FADE TIME	yes
255	QUERY EXTENDED VERSION NUMBER	yes
256	TERMINATE	yes
257	DATA TRANSFER REGISTER (DTR)	yes
258	INITIALISE	yes
259	RANDOMISE	yes
260	COMPARE	yes
261	WITHDRAW	yes
264	SEARCHADDRH	yes
265	SEARCHADDRM	yes
266	SEARCHADDRL	yes
267	PROGRAM SHORT ADDRESS	yes
268	VERIFY SHORT ADDRESS	yes
269	QUERY SHORT ADDRESS	yes
270	PHYSICAL SELECTION	Not implemented
272	ENABLE DEVICE TYPE 6	yes
273	DATA TRANSFER REGISTER 1(DTR1)	yes
274	DATA TRANSFER REGISTER 2(DTR2)	yes
275	WRITE MEMORY LOCATION	yes

**** *Per attivare la funzione NTC togliere il Jumper JP51. Inoltre un problema della lampada può essere comunicato all'alimentatore attraverso la porta NTC cortocircuitando questa o lasciandola aperta .*

To activate the NTC port remove the JP51 Jumper. Moreover a failure of the lamp can be communicated to the PS through the NTC port by short-circuiting it or leaving it open.

ENTE EMITTENTE: _____ Compilato: _____ Visto: _____