

# VEGA 75W - 320W FPD IP67

**Direct current dimmable electronic drivers**  
**Alimentatori elettronici regolabili in corrente continua**



- (1) Referred to  $V_{in} = 230\text{ V}$ , 100% load  
Riferito a  $V_{in} = 230\text{ V}$ , carico 100%
- (2) Referred to  $V_{in} = 100\text{--}200\text{ V}$ , 100% load  
Riferito a  $V_{in} = 100\text{--}200\text{ V}$ , carico 100%
- (3)  $P_{out} > 42\text{ W}$

Article - Articolo	Code - Codice
FPD PROGRAMMING TOOL 2.0	127094
LINK TO DOWNLOAD PROGRAMMING SOFTWARE LINK PER SCARICARE SOFTWARE DI PROGRAMMAZIONE	
<a href="http://www.tci.it/TCI_tools/VEGA_SOFTWARE_2.0.zip">www.tci.it/TCI_tools/VEGA_SOFTWARE_2.0.zip</a>	



## 4.4

High power programmable

### Rated Voltage Tensione Nominale

100 ÷ 200 V<sup>(4)</sup>  
200 ÷ 240 V  
277 V

### Frequency Frequenza

50-60 Hz

### AC Operation range Tensione di utilizzo AC

90 ÷ 305 V

### Power - Potenza

35 ÷ 320 W

### iTHD

≤ 10%<sup>(1)</sup>

### Stand by power

≤ 0,5 W

### Output current ripple

≤ 5%<sup>(1)</sup>

### Standards compliance

EN 55015  
EN 61000-3-2  
EN 61000-3-3  
EN 61347-1  
EN 61347-2-13  
EN 61547  
EN 62384  
EN 62493  
UL 8750

### Max. pcs for CB B16A

(see page info17)

75W: 11 pcs  
105W: 6 pcs  
150W: 5 pcs  
200W: 4 pcs  
240W: 4 pcs  
320W: 2 pcs

### In rush current

75W: 38A 312μsec  
105W: 39A 456μsec  
150W: 40A 592μsec  
200W: 40A 652μsec  
240W: 41A 764μsec  
320W: 100A 846μsec

Article Articolo	Code Codice	P out W	V out DC	I out DC	Default I out DC	U out V	ta °C	tc °C	λ max. Power Factor <sup>(2)</sup>	η max. Efficiency <sup>(1)</sup>
<b>VEGA 75/940-1880 FPD IP67</b> <sup>(6)</sup>	127848	35...75	38...62	940...1880 mA cost.	1400 mA	70	-40...+60/50 <sup>(4)</sup>	90	0,95 <sup>(3)</sup>	> 89 %
<b>VEGA 105/1250-2500 FPD IP67</b>	127830	47...105	38...62	1250...2500 mA cost.	2100 mA	70	-40...+60/50 <sup>(4)</sup>	90	0,95	> 91 %
<b>VEGA 150/1800-3600 FPD IP67</b>	127831	68...150	38...62	1800...3600 mA cost.	3150 mA	70	-40...+60/50 <sup>(4)</sup>	90	0,95	> 91 %
<b>VEGA 200/2500-5000 FPD IP67</b>	127832	95...200	38...62	2500...5000 mA cost.	4900 mA	70	-40...+60/50 <sup>(4)</sup>	90	0,95	> 92 %
<b>VEGA 240/2850-5710 FPD IP67</b>	127833	108...240	38...62	2850...5710 mA cost.	5000 mA	70	-40...+60/50 <sup>(4)</sup>	90	0,95	> 92 %
<b>VEGA 320/3750-7500 FPD IP67</b>	127862	142...320	38...62	3750...7500 mA cost.	6700 mA	70	-40...+60/50 <sup>(4)</sup>	90	0,95	> 92 %

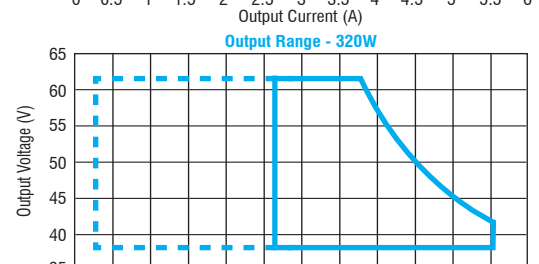
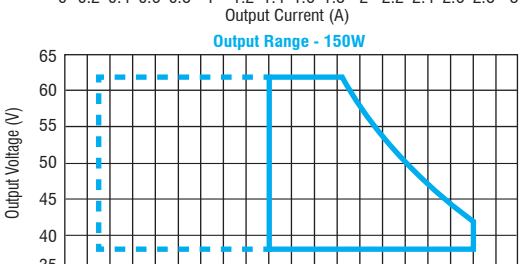
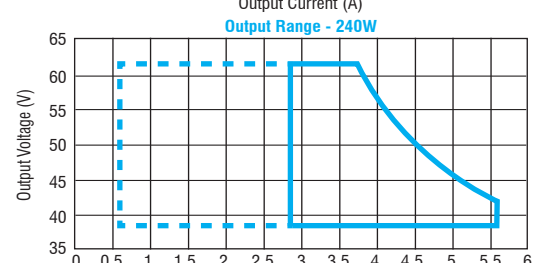
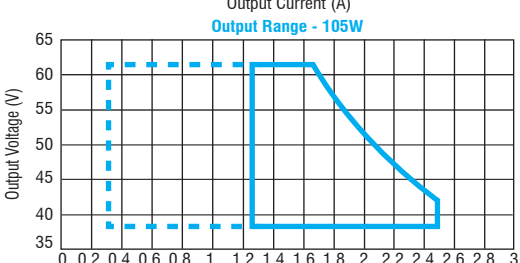
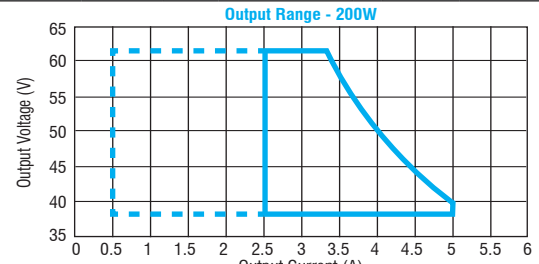
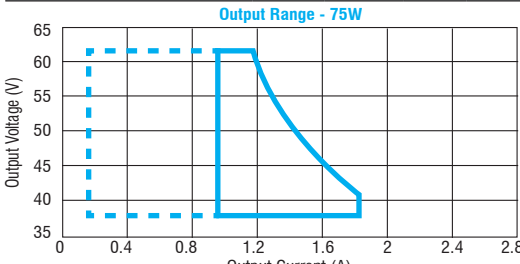

Programmed Range

### Features

- Independent driver with case IP67 (see page info7 for the correct connection of connecting leads/tails).
- Class I protection against electric shock for direct or indirect contact.
- Active Power Factor Corrector.
- Current regulation ± 5 % including temperature variations.
- Supplied with connecting leads/tails on primary and secondary circuits for connection.
- Protections:
  - against overheating and short circuits;
  - against mains voltage spikes;
  - against overloads.
- Thermal protection = C.5.a. - C.5.e.<sup>(6)</sup>

### Caratteristiche

- Alimentatore indipendente con case IP67 (vedi pagina info7 per il corretto collegamento dei cavi di connessione).
- Protetto in classe I contro le scosse elettriche per contatti diretti e indiretti.
- PFC attivo.
- Corrente regolata ± 5 % incluse variazioni di temperatura.
- Fornito di cavi di connessione su primario e secondario per il collegamento.
- Protezioni:
  - termica e cortocircuito;
  - contro le extra-tensioni di rete;
  - contro i sovraccarichi.
- Protezione termica = C.5.a. - C.5.e.<sup>(6)</sup>

The data shown are preliminary and may change - I dati riportati sono preliminari e potrebbero subire variazioni

**Direct current dimmable electronic drivers**  
**Alimentatori elettronici regolabili in corrente continua**

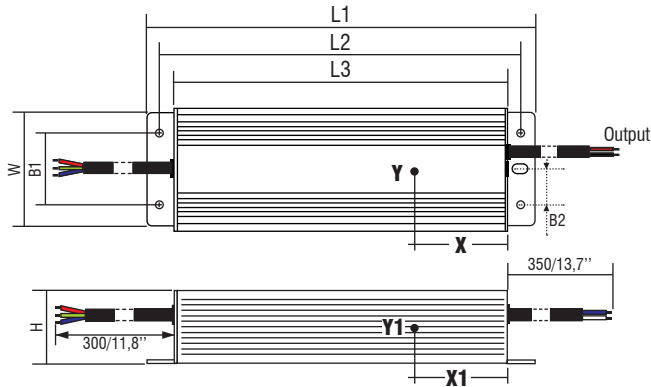

Article Articolo	Dimensions - Dimensioni						Weight - Peso	Tc C°			
	L1	L2	L3	W	H	B1		X	Y	X1	Y1
<b>VEGA 75/940-1880 FPD IP67</b>	128	117	114	68	37	34	gr. 500 / 17,6 oz.	-	-	46	25
<b>VEGA 105/1250-2500 FPD IP67</b>	153	142	139	68	37	38	gr. 700 / 24,7 oz.	58	48	-	-
<b>VEGA 150/1800-3600 FPD IP67</b>	173	162	159	68	37	34	gr. 1000 / 35,3 oz.	49	44	-	-
<b>VEGA 200/2500-5000 FPD IP67</b>	193	182	179	68	40	34	gr. 1200 / 42,3 oz.	73,5	28,5	-	-
<b>VEGA 240/2850-5700 FPD IP67</b>	208	198	194	68	40	34	gr. 1100 / 38,8 oz.	-	-	88,5	26,5
<b>VEGA 320/550-1100 FPD IP67</b>	231	220	216	98	42	40	gr. 1550 / 54,6 oz.	65	25	-	-

4.4

High power programmable

**Wiring diagrams - Schemi di collegamento** (Max. LED distance at page info8 - Massima distanza LED a pagina info8)

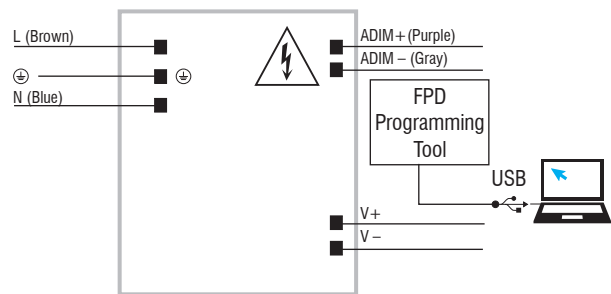
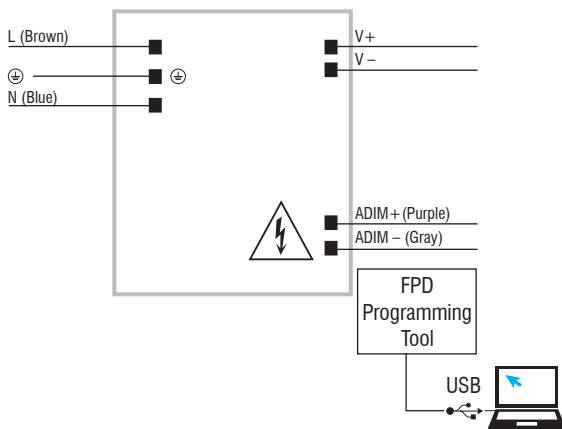

Diagram for 320 W - Collegamento per 320 W

### Operation Mode

- **FULL PROGRAMMABLE (FPD)** devices allow the user to set different parameters without need of switching on the product.
  - The **FULL PROGRAMMABLE (FPD)** functions can be set with the **FPD PROGRAMMING TOOL** interface through **0/1...10 V** port.
  - Light regulation: 0/10-100% by means of 0/1...10 V local interface.
  - The main available features are:
    - **CLO** (Constant Light Output);
    - **MIDNIGHT**: automatic dimming according to programmed parameters;
- For additional details for regulations see pages info12-14.

### Modalità di funzionamento

- I dispositivi **FULL PROGRAMMABLE (FPD)** permettono all'utente di impostare diversi parametri senza la necessità di accendere il prodotto.
  - Le funzioni **FULL PROGRAMMABLE (FPD)** possono essere impostate con l'interfaccia **FPD PROGRAMMING TOOL** tramite porta **0/1...10 V**.
  - Regolazione della luminosità: 0/10-100% mediante interfaccia locale 0/1...10 V.
  - Le principali caratteristiche disponibili sono:
    - **CLO** (Constant Light Output);
    - **MIDNIGHT**: regolazione automatica secondo i parametri programmati.
- Per ulteriori dettagli sulle regolazioni vedi pagine info12-14.